



## SPECIFICATIONS

MODEL	WIN-CBED-120W-ED
Watts	120W
Input Voltage	AC100-277V 50-60Hz
CCT	2700-7000K
Power Factor	≥0.9
CRI	>80
Lumen	12600±630lm
Brand	Samsung
LED Quality	336 LEDs 0.3W
LED LM80	Yes
BASE	E39/E40



Samsung  
LM561B



MEAN WELL



E40



JAE  
Connector

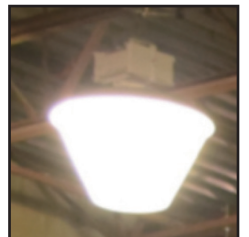

## WIRING DIAGRAM

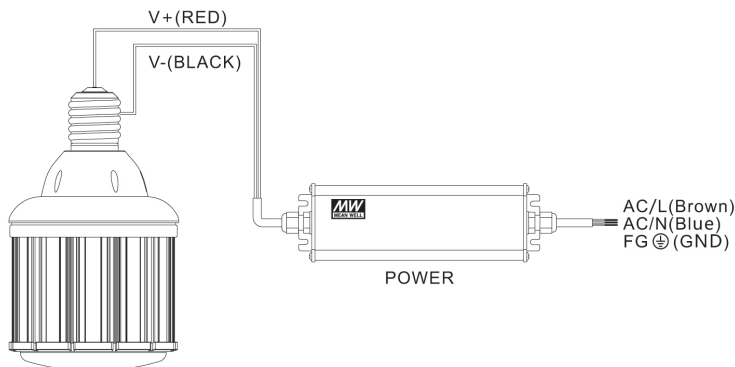

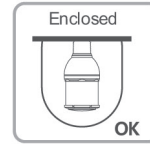
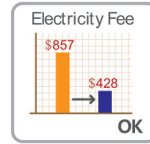
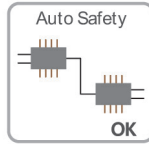
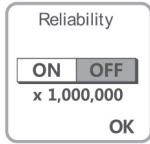

## DIMENSIONS

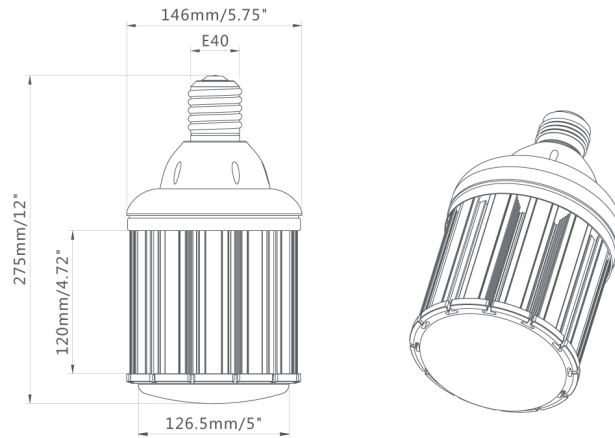

## LUMINOUS EMITTANCE

